

<b>Handset Parts</b> .....	<b>1-2</b>
Parts & Functions .....	1-2
<b>Charging Battery</b> .....	<b>1-4</b>
Charging Battery (AC Charger) .....	1-4
Charging Battery (In-Car Charger).....	1-5
<b>Power On/Off</b> .....	<b>1-6</b>
Handset Power On/Off.....	1-6
<b>Display &amp; Indicators</b> .....	<b>1-7</b>
Display .....	1-7
Indicators .....	1-8
<b>Accessing Functions</b> .....	<b>1-11</b>
Shortcuts Menu & Key Shortcut ....	1-13
Toggling Active Functions (Multi Job)	
.....	1-14
Standby Shortcuts .....	1-15
Using Simplified Menus (Simple Menu)	
.....	1-16
Cycloid Position Setup.....	1-17

<b>TOUCH CRUISER</b> .....	<b>1-18</b>
Using TOUCH CRUISER .....	1-18
<b>Motion Control</b> .....	<b>1-19</b>
<b>Mobile Manners</b> .....	<b>1-21</b>
<b>Security Codes</b> .....	<b>1-22</b>
<b>Basic Tools</b> .....	<b>1-23</b>
My Details & Basic Tools .....	1-23
<b>Double Number</b> .....	<b>1-25</b>
Using Double Number.....	1-25
Modes.....	1-26
<b>Additional Functions</b> .....	<b>1-28</b>
<b>Troubleshooting</b> .....	<b>1-31</b>

# 1

## Getting Started

## Parts & Functions

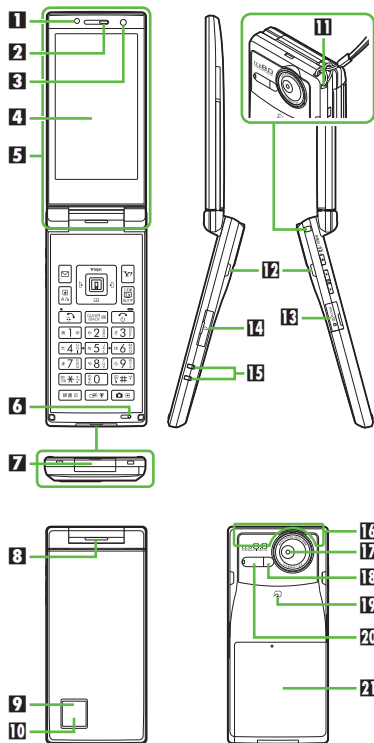

- 1** Light Sensor
- 2** Earpiece
- 3** Internal Camera
- 4** Display
- 5** TV Antenna Location
- 6** Microphone
- 7** External Device Port (with Port Cover)
- 8** Center Speaker
- 9** Small Light
- 10** External Display
- 11** Strap Eyelet
- 12** Stereo Speakers
- 13** Memory Card Slot (with Slot Cover)
- 14** Headphone Port (with Port Cover)
- 15** Charging Terminals
- 16** Internal Antenna Location
- 17** External Camera (lens cover)
- 18** Mobile Light
- 19** Logo
- 20** Infrared Port
- 21** Battery Cover

- Do not cover or place stickers, etc. over Light Sensor or Internal Antenna area.
- Replace Port/Slot Cover after Port/Slot use.
- Avoid metallic straps; Antenna sensitivity may be affected.

### Display Positions

#### Closed Position

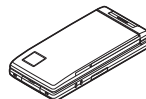

Keep handset closed when not in use.

#### Portrait Position



Open handset to place or answer calls, enter text, etc.

#### Cycloid Position

Open handset and rotate Display 90 degrees clockwise.

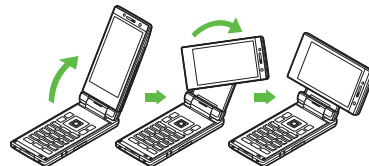

Do not forcefully rotate Display; damage may result.

## Handset Keys

Keys are indicated in this guide as shown.

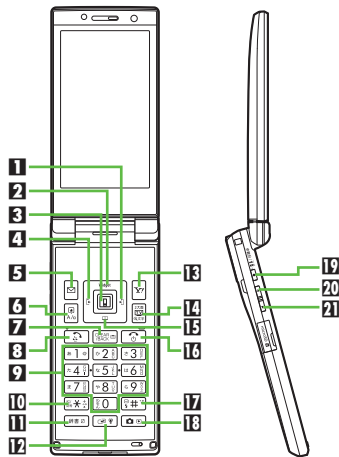
**1 Multi Selector (right)**

Open Received Calls. Long Press to activate/cancel infrared.

**2 Multi Selector (up)**

Open Mobile Widget window. Long Press to open PC Site Browser menu.

**3 Center Key** & **TOUCH CRUISER**

Open Main Menu. Long Press to activate/cancel Keypad Lock.

**4 Multi Selector (left)**

Open Dialed Numbers. Long Press to activate/cancel Bluetooth®.

**5 Mail Key**

Open Messaging menu. Long Press to open S! Mail Composition window.

**6 Shortcuts & A/a Key**

Open Shortcuts menu. Long Press to show active indicators (Status Icon List).

**7 Clear/Back Key**

Play Answer Phone messages. Long Press to activate/cancel Answer Phone.

**8 Start Key**

Open All Calls. Long Press to open Double Number Mode menu.

**9 Keypad**

Enter numbers to place calls or access functions (Quick Operations). Long Press to open Phone Book.

**10 \* Key**

Enter \*, +, P, ? and -. Long Press to open S! Friend's Status member list.

**11 Dictionary Key**

Open Dictionary. Long Press to activate VeilView.

**12 Multi Job & Manner Key**

Select handset mode. Long Press to activate/cancel Manner mode.

**13 Yahoo! Keitai Key**

Open Yahoo! Keitai portal. Long Press to activate Familink Remote.

**14 TV & Text Key**

Activate TV. Long Press to open Change Menu window.

**15 Multi Selector (down)**

Open Phone Book. Long Press to create new Phone Book entries.

**16 Power On/Off Key**

Toggle Standby display. Long Press to turn handset power off.

**17 # Key**

Enter #. Long Press to activate/cancel Manner mode.

**18 Camera Key**

Activate mobile camera. Long press to activate Review.

## Side Keys

**19 S! Circle Talk & Pedometer Key**

**Portrait:** Open S! Circle Talk member list. Long Press to open Pedometer menu.  
**Closed:** Toggle Clock view. Long Press to illuminate Mobile Light.

**20 Volume Up Key**

**Closed:** Scroll External Display indicators. Long Press to check e-money balance.

**21 Volume Down Key**

Long Press to start Simulated Call.  
**Closed:** Scroll External Display indicators.

## Multi Selector &amp; Side Keys

- In this guide, Multi Selector and Side Key operations are indicated as follows:

Press  or	
Press  or	
Press , ,  or	
Press  or	

## 1 Getting Started Charging Battery (AC Charger)

Battery must be inserted in handset to charge it.

- Use specified AC Charger **ZTDAA1** (sold separately) only. In this guide, ZTDAA1 is referred to as "AC Charger."
- Handset and AC Charger may warm during charging.

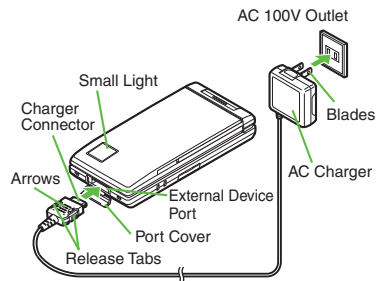

### Important AC Charger Usage Note

- Fold back blades after charging. Do not pull, bend or twist the cord.

### 1 Open Port Cover as shown

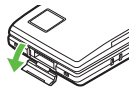

### 2 Connect AC Charger

- With arrows up, insert connector until it clicks.

### 3 Extend blades and plug AC Charger into AC outlet

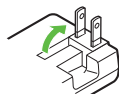

- Small Light illuminates red while charging.
- Small Light goes out when battery is full.

### 4 Unplug AC Charger



- Pull AC Charger straight out.

### 5 Disconnect handset

- Squeeze release tabs to remove connector.

### 6 Fold back blades and replace Port Cover

#### When Small Light Flashes

- Battery is unchargeable; may be defective or simply at the end of its life; replace it.

#### USB Charge

- Connect handset (with power on) to PC via USB Cable to charge battery.

#### Charging Battery Overseas

- SoftBank is not liable for problems resulting from charging battery abroad.

### Advanced

- Disabling USB Charge (P.1-28)

## Charging Battery (In-Car Charger)

In-Car Charger may be purchased separately.

Cigarette Lighter Socket

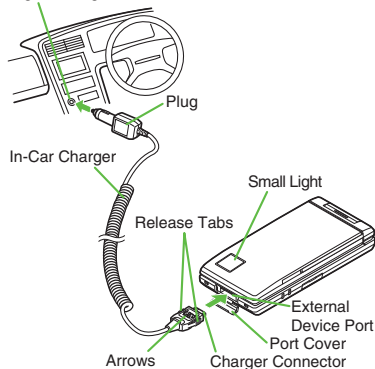

### 1 Open Port Cover as shown

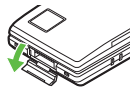

### 2 Connect In-Car Charger

- With arrows up, insert connector until it clicks.

### 3 Plug Charger into cigarette lighter socket

### 4 Start car engine

- Small Light illuminates red while charging.
- Small Light goes out when battery is full.

### 5 Unplug Charger

### 6 Disconnect handset

- Squeeze release tabs to remove connector.

### 7 Replace Port Cover

#### Important In-Car Charger Usage Notes











- Disconnect Charger before leaving vehicle to prevent charging with engine off.
- Do not use In-Car Charger with Desktop Holder.
- Avoid charging battery inside extremely hot vehicles.

# Handset Power On/Off

## Power On

Follow these steps when powering on 932SH for the first time:

### 1 (Long)

- After Power On Graphic, follow the steps below.
-  →  →  →  →  →  → **設定** →  → **Language** →  → **English** →  →  (Long) →  (Long) → Change Menu window opens

### 2 Select option →

Guide descriptions are based on Standard Menu.

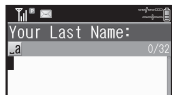

- My Details setup starts.

### 3 Enter last name → → Enter first name →

- Change Menu display option confirmation appears.

### 4 Yes or No →





Standby

- Choose **No** to enter Standby immediately after powering on.

#### When USIM Card is Not Installed

- **Insert USIM Card** appears; insert the card to use handset.

## Retrieving Network Information

Handset initiates Network Information retrieval when ,  or  is pressed for the first time.



Follow these steps to retrieve Network Information to use Network-related services and TV; retrieval automatically sets Clock:

### 1 Yes → → Retrieval starts

### 2

## Power Off

### 1 (Long)

- After Power Off Graphic, handset shuts down.

# Display

## Standby



- Indicators (signal strength, battery strength, etc.) appear.
- Information window opens at the bottom for Missed Calls, new mail, etc.



Information Window

- Information label (e.g., **Message**, etc.) and count appear in Information window. Select an item and press **■** to open it.

## Softkeys

Functions/operations assigned to **☐**, **■** and **▽** appear at the bottom.

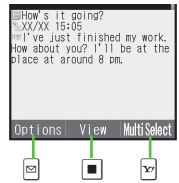

### Display Saving

- Display goes dark after Display Saving time elapses. Press any key to activate it.

### Backlight

- Backlight turns off after Time Out time elapses. Press **F0** - **9** to illuminate it (key press may affect active function).

## Advanced

- Handling Information list (P.1-28)

# Indicators

## Display Indicators

, and indicate line type in Dual Mode (P.1-25).

### Basic Status



1		International roaming in progress
2		Signal strength <sup>1</sup>
3		Packet transmission protocol ready (3G)
		Packet transmission protocol ready (GSM)
		Packet transmission available (3G)
4		Packet transmission available (GSM)
		Battery strength (% <sup>2</sup> appears in turn)
5		IP Service enabled <sup>3</sup>

<sup>1</sup>The more bars the better.

<sup>2</sup>Battery strength % is an approximation.

<sup>3</sup>Appears when Decoration Call, S! Appli communication or Mobile Widget is enabled.

accompanies even if packet transmission is not in progress. Both indicators disappear when Decoration Call, S! Appli Notification Setting and Mobile Widget Notification Setting are **Off**.

### Function Status

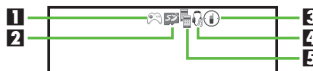

1		Active S! Application
		Paused S! Application
		Music playback in progress
		TV recording in progress (handset)
		TV recording in progress (Memory Card)
2		Memory Card in use
		Memory Card formatting
3		TV Timer/TV Recording Timer set
		Compass Indicator
4		Music playback in progress (via Bluetooth <sup>®</sup> )
5		Multiple functions (Multi Job) active

### Notifications

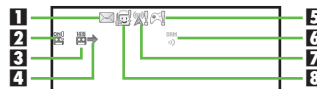

1		Unread mail
		Unread Delivery Report
2		Answer Phone active & message recorded
		Answer Phone canceled & message recorded
3		New Voicemail
4		Missed Call or new mail on idle line
5		S! Appli/Mobile Widget Notification
6		Contents Key received
7		Software Update result
		Unread S! Quick News info
8		Unread S! Friend's Status notification or unanswered registration request

### Warnings



1		Mail memory low
2		Message delivery failure
3		Memory Card unusable/misinserted



## ■ Transmissions

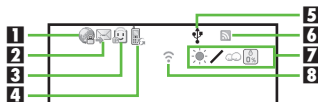

<b>1</b>	SSL browsing in progress <sup>1</sup>
<b>2</b>	Waiting packet transmission (3G)
	Waiting packet transmission (GSM)
<b>3</b>	Receiving mail
	Sending mail
<b>4</b>	S! Friend's Status online
	Positioning in progress <sup>2</sup>
<b>5</b>	Software Update in progress
	USB Cable connected
	USB transmission in progress
	Infrared transmission in progress
	Infrared file transfer in progress
	Bluetooth® transmission ready
	Bluetooth® transmission in progress (  appears for multiple connections)
	Bluetooth® talk in progress
	S! Addressbook Back-up transmission in progress
	PC Site Browser in use
<b>6</b>	RSS-compatible site
<b>7</b>	Weather Indicator
<b>8</b>	Infrared transmission ready

<sup>1</sup>Hidden while Mobile Widget is in use.<sup>2</sup>Flashes while positioning.

## ■ Settings

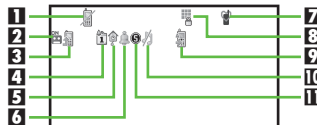

<b>1</b>	Offline Mode active
<b>2</b>	Answer Phone active
<b>3</b>	Call Forwarding or Voicemail active (forwarding condition: <b>Always</b> ) <sup>*</sup>
<b>4</b>	Schedule/Task (Alarm set)
	Schedule/Task (Alarm unset)
<b>5</b>	Hour Minder active
<b>6</b>	Alarm set
	Wakeup TV set
<b>7</b>	Manner mode active
	Drive mode active
	Original mode active
	VeilView active
<b>8</b>	Keypad Lock active
	IC Card Lock active
<b>9</b>	Auto Answer or Remote Monitor active
<b>10</b>	Ringtone (Silent)
	Ringtone (Increasing Volume)
	Vibration active
<b>11</b>	Show Secret Data active
	Function Lock active

<sup>\*</sup>Indicator does not appear when Call Forwarding is set to Video Calls only, with Voicemail unset.

## External Display Indicators

### Basic Status



1		Signal strength*
2		Battery strength

\*The more bars the better.

### Notifications

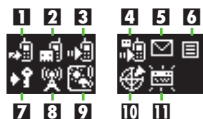

1		Missed Calls
2		Answer Phone message recorded
3		Missed Call Notification
4		New Voicemail
5		New mail
6		New Delivery Report
7		Contents Key received
8		Unread S! Information Channel info
9		Weather Indicator update
10		Location Info request
11		Pedometer target achieved

### Warnings



1		Message delivery failure
2		S! Information Channel info reception failure
3		Decoration Call transmission failure
4		IP Service connection failure
5		Weather Indicator update failure

### Handset Status

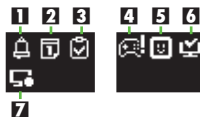

1		Alarm
2		Schedule Alarm
3		Task Alarm
4		S! Appli/Mobile Widget Notification
5		Unread S! Friend's Status notification
6		TV Alarm (watch)
7		TV Alarm (record)

### External Display Date & Time

• Press to toggle Clock view.

## Accessing Functions

Use the following methods as needed.

### Main Menu

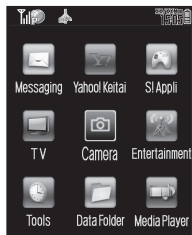

Repeat menu item selection.

Select menu items

Enter numbers

Use shortcuts

### Quick Operations

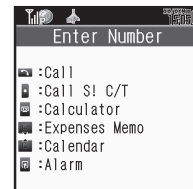

Enter numbers to access functions.  
To activate functions, press the corresponding key.

### Shortcuts



Access assigned functions (changeable).

### Standby Shortcuts

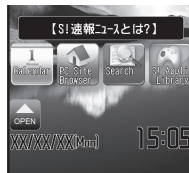

Save functions to Standby.

### Quick Shortcut

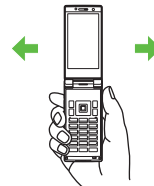

Shake handset to access assigned functions. (Complete setup beforehand.)

Access a function in Shortcuts menu while another is active, then toggle function windows as needed.

Main Menu

1

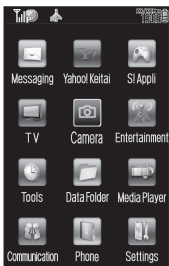

- Main Menu opens.

2 Use to select menu item



- Menu/window opens.
- If Sub Menu opens, use to select an item and press .

Tabs

- Menus/lists in a single window appear in separate tabs; use to toggle tabs.

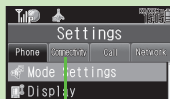

Tab

Reverse Navigation

- Press . If a confirmation appears, follow onscreen prompts.

Returning to Standby

- Press . If a confirmation appears, follow onscreen prompts.

Simple Menu

- Simplify menus and enlarge fonts; ideal for users who use only basic handset functions.

Main Menu Items

<b>Messaging</b>	Open/create messages, etc.
<b>Yahoo! Keitai</b>	Browse the Internet
<b>S! Appli</b>	Use S! Applications including games
<b>TV</b>	Watch/record TV programs
<b>Camera</b>	Capture images or record video
<b>Entertainment</b>	Read e-Books, receive news updates, etc.
<b>Tools</b>	Manage schedules, set Alarm, scan QR Codes, etc.
<b>Data Folder</b>	Open files saved on handset/Memory Card
<b>Media Player</b>	Play/download media files
<b>Communication</b>	Communicate with other users in various ways
<b>Phone</b>	Search contacts, add entries, etc.
<b>Settings</b>	Customize handset interface, sounds, etc.

# Shortcuts Menu & Key Shortcut

## Shortcuts Menu

Access assigned functions via Shortcuts menu.

1 















Shortcuts Menu

2 **Select function**  









- Menu/window opens.

### Changing Default Shortcuts

In 2, select numbered function    
 **Assign Function**    Select menu item    Select new item  

- To assign menu items, select one and press .







### Assigning Files & Folders

In 2, select numbered function    
 **Assign Data**    Select file/folder  

- For folders, select **Set this folder** and press .

## Key Shortcut

Long Press ,  or  to access assigned functions.

	Open S! Mail Composition window
	Activate Familink Remote
	Open PC Site Browser menu
	Create new Phone Book entries
	Activate/cancel Bluetooth®
	Activate/cancel Infrared

## Changing Assigned Functions

Follow these steps to assign Calculator to .

1   **Settings**  

2 **In Phone menu, Set Key Shortcut**  



Key Shortcut Menu

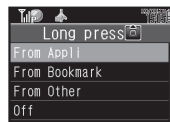

3 **Long press**   



4 **From Appli**  





5 **Tools**    In PIM/Life menu, **Calculator**  

### Bookmark



In 4, **From Bookmark**  

Select title    **Yes**  

Bluetooth® or Infrared On/Off

In 4, **From Other**    Select item  

Canceling Assigned Function

In 4, **Off**  

## Advanced

  Changing item order  Restoring default shortcuts (P.1-28)

# 1 Getting Started

## Toggling Active Functions (Multi Job)

### Multi Job Feature

Access a function in Shortcuts menu while another is active.

While browsing the Internet

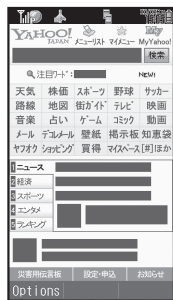

① Open Scratch Pad

② Toggle windows



Jot down information

Multi Job may not activate from some menus/windows (e.g., ringtone/ringvideo selection, etc.). Multi Job is disabled while  (gold) appears.

### Using Multi Job

① In a function window,  In text entry/dial windows, Long Press .

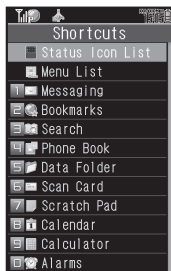

② Select function 



• Menu/window opens.

③ To toggle active windows, 

















④  **Multi Job ends**  
 • If a confirmation appears, follow onscreen prompts.

## Standby Shortcuts

Paste shortcuts to functions, files, folders, etc. to Standby for easy access.

### Saving Shortcuts to Standby

- 
  - Pointer (↔) appears.
-  Use  to select  (OPEN)
   

  

  - Press  to toggle selection.
  - Alternatively, use  to point to  (OPEN) and press .
-  
  

-  **Select item** 
  - Corresponding icon appears in Standby.
  - >> appears when more items are available.

### Advanced







-   Reversing icon selection order with   Editing sheet names  Locking sheets (P.1-28)

-  Use  to specify target location 











### Saving from Menu/Window

- In Options menu, select **Set as StbyShortcut** (may not appear for some items); select sheet as needed.









### Removing Shortcuts from Standby

-   Use  to select icon 
  
**Operation**    
  
**Yes** 





### Moving Icons

-   Use  to select icon 
  
**Operation**    
  
  Specify target location 

### Moving Icons to Front/Back

-   Use  to select icon 
  
**Operation**    

### Using Shortcuts



-   Use  to select icon 
  - Menu/window opens or command is executed.

### toggling Sheets

Toggle sheets to use Standby shortcuts and widgets pasted on each sheet.

-    (Long)



- To toggle further, Long Press  or press  repeatedly.
- Sheet name appears at the top, then disappears.
- Save Standby shortcuts as needed; corresponding icons appear on the current sheet.

### Using Locked Sheets

-     
  
**Handset Code** 

# 1 Using Simplified Menus (Simple Menu)

Getting Started

## Simple Menu Features

Activate Simple Menu to reduce available handset functions and simplify menus.

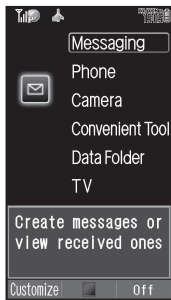

- Fonts are enlarged and appear in bold.
- Clock is enlarged (Calendar is hidden).
- Motion Control and TOUCH CRUISER are unavailable.

## Menu Items

<b>Messaging</b>	Received Msg., Create Msg., Drafts, Templates, Sent Messages, Unsent Msg., Create SMS
<b>Phone</b>	Phone Book, Add New Entry, Play Messages, Answer Phone, Call VM, My Details, Speed Dial/Mail
<b>Camera</b>	Photo Camera, Video Camera, Scan Barcode, Scan Card, Scan Text, Review, Camera Settings, Video Settings, SetCameraKey
<b>Convenient Tool</b>	Calendar, Alarms, Calculator, Assignment, Dictionary, Notepad, S! GPS Navi, Pedometer, Compass, S! Friend's Status, S! Circle Talk, Double Number, Change Menu
<b>Data Folder</b>	-
<b>TV</b>	-

Key assignments are largely the same as in Standard Menu.

## Activating Simple Menu

1 (Long)

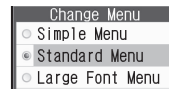

2 **Simple Menu** →

3 **Select Talk Mode** → →

4 **Select Voice Clear option** → →

### While Using an Incompatible Function

- End the function before activating Simple Menu.

### Canceling Simple Menu

(Long) → **Standard Menu** →

## Talk Mode & Voice Clear

Improve Earpiece sound quality.

### Talk Mode

<b>Slow Talk</b>	Reduce Earpiece noise and improve voice audibility
<b>Noise Reduction</b>	Reduce Earpiece noise

### Voice Clear

Boost high frequencies to improve the audibility of other party's voice.



## Cycloid Position Setup

Set handset to automatically execute one of these actions upon Display rotation:

<b>Activate Digital TV</b>	Activate TV
<b>Show TV Menu</b>	Access TV functions
<b>Show AV Menu</b>	Activate mobile camera or access S! Applications, images and media files
<b>Show Internet Menu</b>	Open Bookmarks/ received messages or activate PC Site Browser/ Document Viewer
<b>Show Main Menu</b>	Open Main Menu
<b>Launch Appli</b>	Access assigned function
<b>Connect Bookmark</b>	Access saved URL
<b>Off(Standby)</b>	Keep Standby

Upon first rotation, setup menu opens.

### 1 Rotate Display (first time)

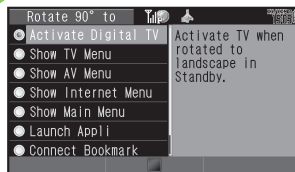

Landscape Menu

### 2 Select item →

- Setting is applied and Landscape setup option confirmation appears.

### 3 Yes or No →

- Selection appears.

#### Launch Appli or Connect Bookmark

- Handset accesses the assigned function or URL; change function/URL as needed.

### Changing Applied Setting

When **SetRotation** Softkey appears in Cycloid Position menus, etc., press  to change setting.



### 1

- Landscape menu opens.

### 2 Select item →

#### From Standby

- **Settings** →  → **In Phone menu, Display Rotation** →  → **Rotate 90° to** →  → **Rotate 90° to** →  → **Select item** →

### Advanced

-  ● Changing function assigned to Launch Appli in landscape menu ● Changing URL assigned to Connect Bookmark in landscape menu (P.1-28)

## Using TOUCH CRUISER

Slide finger over Center Key to move cursor, pointer, etc. (Not available for Calculator or some other functions.)

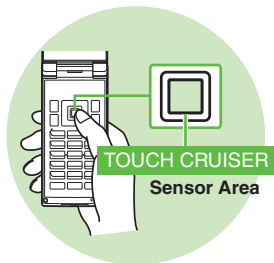

### Activating TOUCH CRUISER

Touch Center Key until cursor, pointer, etc. moves. (TOUCH CRUISER activates.)

When finger is released, TOUCH CRUISER deactivates after a period of inactivity.

### Selection & Execution

Cursor, pointer, etc. moves multi-directionally according to finger movement; select item. Press Center Key to execute selection.

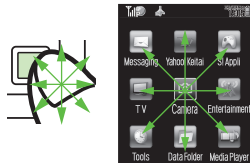

### Important TOUCH CRUISER Usage Notes

- Do not use a pen or other sharp object.
- Do not use with gloved fingers.
- Do not place stickers, etc. over Center Key.
- Clean with a dry, soft cloth.
- Performance may be affected by direct sunlight; use Multi Selector.

### Advanced

- Disabling TOUCH CRUISER
- Changing activation timing/method
- Changing inactivity time limit
- Changing cursor speed (P.1-29)

# Motion Control

Sensor detects handset orientation or movement. Move handset to navigate pages, access functions, etc.

- Cancel Keypad Lock and activate Display first.
- Adjust Motion Control sensor (**P.1-29**) before using Motion Control for the first time.
- Activate Motion Control by function beforehand.

## Turn Over

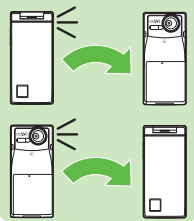

## Quick Shortcut

Shake handset left and right approximately three times in Standby to access assigned functions.

- Change assigned functions as needed.

### Activate Camera

Portrait Position

### Activate TV

Cycloid Position

## Shake Left/Right

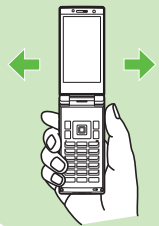

## Activate Quick Silent

Turn handset over to instantly mute ringer and stop vibration.

### Ringer

Incoming Calls, Alarms, etc.

### Vibration

Incoming Calls, Alarms, etc.

- Some tones may not be silenced.

## Navigate Functions

Shake to the left to navigate back, or right to navigate forward.

### Music

Music Player

### Channels

TV

### Images

Data Folder (Pictures)

### Pages

Document Viewer

## Multi Job

Shake to the left or right to toggle active windows

### Toggle Windows

Multi Job

## Shake Forward or Backward

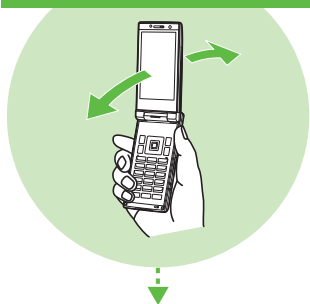

## Zoom In/Zoom Out

Shake forward to enlarge, or backward to reduce.

## Fonts

Yahoo! Keitai  
Message Window

## Zoom Image

Data Folder  
(Pictures)

## Zoom Page

PC Site Browser  
Document Viewer

## Toggling Motion Control On/Off

1  → **Settings** →

2 In Phone menu, **Motion Control** →

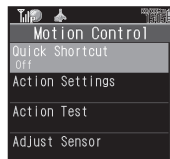

Motion Control Menu

3 **Action Settings** →

4 **Select function** →

5 **On or Off** →

## Enabling Quick Shortcut

1 In Motion Control menu, **Quick Shortcut** →

2 **Switch On/Off** →

3 **On** →

Activating Show Secret Data Temporarily  
Enter Handset Code → Shake  
handset left or right

- Close handset in Standby to cancel Show Secret Data.

## Important Motion Control Usage Notes

- Hold/shake handset correctly to avoid unintended results.
- Motion Control may be unavailable while handset is ringing/vibrating.
- Confirm there is ample space for Motion Control use; hold handset firmly and shake it gently to avoid injury/breakage. Do not shake handset roughly; handset may slip, resulting in injury or damage.

## Advanced

- Changing Quick Shortcut items ● Practicing Motion Control actions ● Adjusting Motion Control sensor (P.1-29)

## Mobile Manners

Please use your handset responsibly. Use these basic tips as a guide. Inappropriate handset use can be both dangerous and bothersome. Please take care not to disturb others when using your handset. Adjust handset use according to your surroundings.

- Turn it off in theaters, museums and other places where silence is the norm.
- Refrain from using it in restaurants, hotel lobbies, elevators, etc.
- Observe signs and instructions regarding handset use aboard trains, etc.
- Refrain from use that interrupts the flow of pedestrian or vehicle traffic.

### Manner Mode

Mutes most handset function sounds.

1  (Long)



- Manner mode is set.

#### When Manner Mode is Active

- Ringtones and other sounds are muted.
- 932SH vibrates for transmissions/alerts.
- Shutter click still sounds at fixed volume.

#### Canceling Manner Mode

 (Long)

### Offline Mode

Temporarily suspends all transmissions.

1   **Settings**  

#### Network

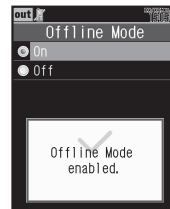

2 **Offline Mode** 

3 **On** 



- Offline Mode is set.

#### Canceling Offline Mode

In  **Off** 

### Advanced

-   Changing handset modes  Creating a custom mode  Resetting Mode Settings (P.1-29)

## Security Codes

These codes are required for handset use.

- Write down Security Codes.
- Do not reveal Security Codes. SoftBank is not liable for misuse or damages.

<b>Handset Code</b>	9999 by default; use or change some functions
<b>Center Access Code</b>	4-digit code selected at contract; access Optional Services via landlines or change contract details
<b>Network Password*</b>	4-digit code selected at contract; restrict incoming/outgoing calls (Call Barring)

\*Change as needed.

### Incorrect Code Entry

- **Handset code is incorrect!** appears; try again.
- If Network Password is incorrectly entered three times consecutively, Call Barring settings are locked. To resolve, Network Password and Center Access Code must be changed.

### Changing Handset Code

Enter four to eight digits for new Handset Code.

1 **Settings**



Phone Menu

2 **Locks**

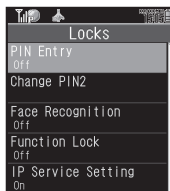

3 **Chg. Handset Code**



4 **Enter current Handset Code**



5 **Enter new Handset Code**



6 **Re-enter new Handset Code**

## My Details & Basic Tools

### My Number

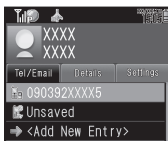

- Handset phone number and the name entered at initial setup appear.

### Editing My Details

After 1, (select tab) ➔ Select item  
➔ ➔ Select item ➔ ➔ Edit ➔

### VeilView

Activate VeilView to prevent peeking.



### Canceling VeilView

(Long)

### Keypad Lock

Lock handset keys and prevent accidental operation/function activation.



- Keypad Lock activates.
- does not turn off handset power.

### Incoming Calls while Keypad Lock is Active

- Keypad Lock is temporarily canceled; press to answer calls. Keypad Lock reactivates after the call.

### Canceling Keypad Lock

(Long)

### Pen Light



- Mobile Light illuminates.



### Important Pen Light Usage Note

- Do not point Pen Light at people or look at it directly.

### Battery Meter



- Approximate battery strength appears.

### Changing Battery Strength Indicator Pattern

After 2, ➔ Select pattern ➔

- Remaining time is approximated for current handset usage pattern.

### Phone Help

Access this handy guide to handset settings and key functions/shortcuts.



- For *Indicators*, select category and press .

## Advanced



- Clearing My Details Toggling My Details in Dual Mode Changing battery strength indicator pattern Changing VeilView pattern/density (P.1-30)

## Indicator Descriptions

Check active indicators and their descriptions. (Status Icon List)

### 1 (Long)



- Active indicators are enlarged; description for selected indicator appears.
- Use  to select indicators to view their descriptions.
- Press  to open menu/window (e.g., Battery Meter window from battery strength indicator). May be unavailable for some indicators.

## S! Town (Japanese)

Select an avatar to enter this 3D virtual town, where you can play games and meet other users.

- To use S! Town, agree to the terms of service then complete free user registration.
- Internet connection is required; may incur high charges.

### 1 ➔ **Communication** ➔

### 2 **S! Town** ➔

- S! Town (S! Application) starts.
- Refer to the S! Town help menu for operational instructions.
- If an upgrade notice appears, follow onscreen instructions to upgrade.

## S! Town Library

- Downloaded S! Town-compatible S! Applications are saved to S! Town Library. To start an application in S! Town Library, follow these steps:

 ➔ **Communication** ➔  ➔

**S! Town** ➔  ➔ **Select application**

➔ 

## S! Loop (Japanese)

S! Loop is an online communication service. Share your diary, join BBS, etc. Internet connection is required; may incur high charges.

### 1 ➔ **Communication** ➔

### 2 **S! Loop** ➔

- Refer to the S! Loop help menu for operational instructions.



## Using Double Number

Manage two accounts (Line A and Line B, with separate phone numbers and mail addresses) on one handset.

- Double Number requires a separate contract and basic monthly fee.
- While abroad, any Line B messaging charges are applied to Line A.
- For more information, see SOFTBANK MOBILE Corp. Website (P.15-23).

### Two Phone Numbers & Two Mail Addresses

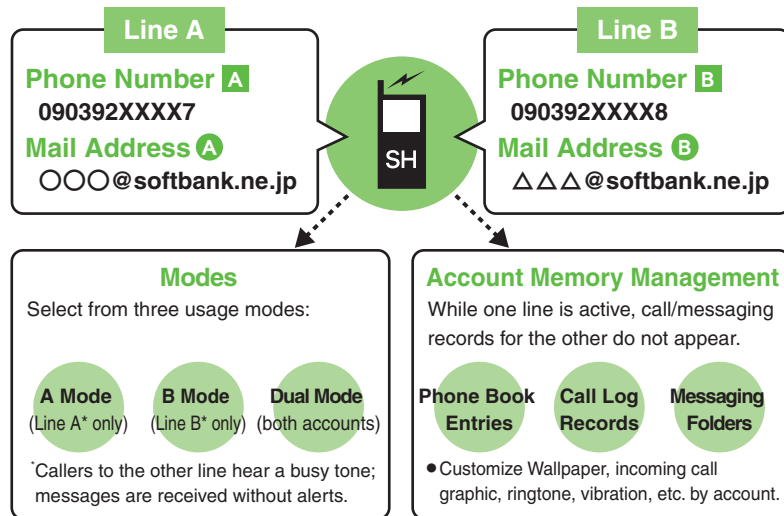

### Activating Double Number

Make sure signal is stable.

- 1  ➔ **Settings** ➔
- 2 In Phone menu, **Double Number** ➔
- 3 **Switch On/Off** ➔
- 4 **On** ➔
- 5 **Enter Handset Code** ➔  ➔ **Yes** ➔

### Canceling Double Number

- In **4**, **Off** ➔  ➔ **5**
- When Double Number is canceled:
    - Line B calls and SMS messages are redirected to Line A Phone Number.
    - Initial portion of Line B S! Mail is redirected to Line A. (Full messages are irretrievable.)
    - Double Number account is not affected.

# Modes

Activate **A Mode** to use Line A only, **B Mode** to use Line B only, or **Dual Mode** to use both accounts.

## A Mode

### Receive Calls to Line A Only

- Place calls or send messages via Line A.

#### A Mode & B Mode Precautions

- Line indicators do not appear in Phone Book entries, message lists, Call Log records, etc.
- When an operation affects information on the other line, a confirmation appears. Follow onscreen prompt(s).

## B Mode

### Receive Calls to Line B Only

- Place calls or send messages via Line B.

#### B Mode Restrictions

- Handset connects to the Internet via Line A. (During Internet connections, place/receive calls via Line B.)
- S! Friend's Status, S! Circle Talk and Decoration Call are unavailable.

## Advanced

- Omitting Handset Code entry when switching modes
- Renaming Double Number modes
- Showing indicator for calls missed or new mail on idle line
- Hiding Internet connection confirmation (P.1-30)

## Dual Mode

## Receive Calls to Both Accounts

- Place calls or send messages via Line A (or the account of record for Phone Book entries or Call Log records) by default; toggle accounts as required.

## Phone Book Entries

Specify A, B or Dual.

## Messaging



Select Line A or Line B.  
Sender Address changes accordingly.

## Calling





Select Line A or Line B.  
Caller ID changes accordingly.

-  **B** and  indicate line type in Phone Book entries, message lists, Call Log records, etc.

## Switching Modes

-  (Long)
- Enter Handset Code → 
- Select mode → 
  - For *B Mode* confirmation appears.
- Yes → 

## Saving Modes to Phone Book Entries

-  → *Phone* →  → *Add New Entry* → 
- Mode:* →  → *Select mode* → 

## Entries Saved with Double Number Off

- Dual* is set automatically.

## Advanced

-   Rejecting calls to either line in Dual Mode
-  Setting main line for Dual Mode (P.1-30)

USB Charge	
Disabling USB Charge	<p>Settings → Connectivity → USB Charge → Disable</p>
Information	
Handling Information list	<p>Start Here → Phone → See below</p>
	<p>Opening List Manually Information</p>
	<p>Clearing List Information → Yes</p>
Shortcuts	
Changing item order	<p>Select numbered function → Move → Select target location</p>
Restoring default shortcuts	<p>Select numbered function → Set to Default → Yes</p>
Standby Shortcut (Sheets)	
Reversing icon selection order with	<p>Move Focus(Reverse)</p> <ul style="list-style-type: none"> <li>To cancel, select <i>Move Focus(Order)</i>.</li> </ul>
Editing sheet names	<p>Start Here → Sheet Settings → Change Sheet Name → See below</p>
	<p>Renaming Select sheet → Enter name</p>
	<p>Resetting All Sheet Names → Yes</p>

Locking sheets	<p>Start Here → Sheet Settings → Set Sheet Lock → Enter Handset Code → See below</p>
	<p>Activating Lock Select sheet → On</p>
	<p>Changing Method for Temporary Access Unlock Method → No Password</p> <ul style="list-style-type: none"> <li>Press [X], then select [Y] and press [Z] to unlock sheet temporarily.</li> </ul>
Cycloid Position	
Changing function assigned to Launch Appli in landscape menu	<p>Settings → In Phone menu, Display Rotation → Rotate 90° to → Set Appli → Select menu item → Select new item</p>
Changing URL assigned to Connect Bookmark in landscape menu	<p>Settings → In Phone menu, Display Rotation → Rotate 90° to → Set Bookmark → Select Bookmark entry → Yes</p>

TOUCH CRUISER	
Disabling TOUCH CRUISER	<ul style="list-style-type: none"> <li>■ → Settings → ■ → In Phone menu, <b>TOUCH CRUISER</b> → ■ → <b>Switch On/Off</b> → ■ → <b>Off</b> → ■</li> </ul>
Changing activation timing/method	<ul style="list-style-type: none"> <li>■ → Settings → ■ → In Phone menu, <b>TOUCH CRUISER</b> → ■ → <b>Cursor Trigger</b> → ■ → Select option → ■</li> </ul>
Changing inactivity time limit	<ul style="list-style-type: none"> <li>■ → Settings → ■ → In Phone menu, <b>TOUCH CRUISER</b> → ■ → <b>Cursor Sustained</b> → ■ → Select time → ■</li> </ul>
Changing cursor speed	<ul style="list-style-type: none"> <li>■ → Settings → ■ → In Phone menu, <b>TOUCH CRUISER</b> → ■ → <b>Cursor Speed</b> → ■ → Select speed → ■</li> </ul>
Motion Control	
Changing Quick Shortcut items	<ul style="list-style-type: none"> <li>■ → Settings → ■ → In Phone menu, <b>Motion Control</b> → ■ → <b>Quick Shortcut</b> → ■ → <b>Shortcut Entry</b> → ■ → <b>Open Position or Cycloid Position</b> → ■ → Select menu item → ■ → Select new item → ■</li> </ul>
Practicing Motion Control actions	<ul style="list-style-type: none"> <li>■ → Settings → ■ → In Phone menu, <b>Motion Control</b> → ■ → <b>Action Test</b> → ■ → Select item → ■</li> <li>• Follow onscreen instructions.</li> </ul>

Adjusting Motion Control sensor	<ul style="list-style-type: none"> <li>■ → Settings → ■ → In Phone menu, <b>Motion Control</b> → ■ → <b>Adjust Sensor</b> → ■</li> <li>• Follow onscreen instructions.</li> <li>• Avoid adjusting sensor near metal/magnetic objects or aboard trains or in vehicles.</li> </ul>
Mode	
Changing handset modes	<ul style="list-style-type: none"> <li>Start Here ■ → Settings → ■ → In Phone menu, <b>Mode Settings</b> → ■ → See below</li> <li><b>Selecting a Handset Mode</b></li> <li>Select mode → ■</li> <li><b>Customizing Handset Modes</b></li> <li>Select mode → [OK] → Select item → ■ → Adjust settings</li> <li>• Not available for Normal mode.</li> </ul>
Creating a custom mode	<ul style="list-style-type: none"> <li>■ → Settings → ■ → In Phone menu, <b>Mode Settings</b> → ■ → <b>Original</b> → [OK] → Select item → ■ → Adjust settings</li> </ul>
Resetting Mode Settings	<ul style="list-style-type: none"> <li>■ → Settings → ■ → In Phone menu, <b>Mode Settings</b> → ■ → Select mode → [V] → Enter Handset Code → ■ → Yes → ■</li> </ul>

## My Details

Clearing My Details	<ul style="list-style-type: none"> <li>▣ → <b>F0</b> → <b>☰</b> → <i>Reset My Details</i> → ▣ → ▣</li> <li>Yes → ▣</li> </ul>
Toggle My Details in Dual Mode	<ul style="list-style-type: none"> <li>▣ → <b>F0</b> → <b>☰</b> → <i>Switch to B or Switch to A</i></li> <li>→ ▣</li> </ul>

## Battery Meter

Changing battery strength indicator pattern	<ul style="list-style-type: none"> <li>▣ → <i>Settings</i> → ▣ → In Phone menu, <i>Display</i> → ▣</li> <li>→ <i>Mini Battery</i> → ▣ → <i>Select pattern</i> → ▣</li> </ul> <ul style="list-style-type: none"> <li>• For patterns other than <b>Clock &amp; Battery</b>, indicators appear in turn. To change interval, press <b>☰</b>.</li> <li>• For <b>Battery level</b> (or <b>Level</b>), approximate battery strength appears as a percentage.</li> <li>• <b>Remaining time</b> is approximated for current handset usage pattern.             <ul style="list-style-type: none"> <li>▣ Remaining time is hidden while charging.</li> </ul> </li> </ul>
---	--

## VeilView

Changing VeilView pattern/density	<ul style="list-style-type: none"> <li><b>Start Here</b> ▣ → <i>Settings</i> → ▣ → In Phone menu, <i>Display</i> → ▣ → <i>VeilView</i> → ▣ → See below</li> </ul>
	<p><b>Pattern</b></p> <ul style="list-style-type: none"> <li><i>Pattern Setting</i> → ▣ → <i>Select pattern</i> → ▣ → ▣</li> <li><i>Select scale or Animation</i> → ▣</li> </ul>
	<p><b>Density</b></p> <ul style="list-style-type: none"> <li><i>Density Setting</i> → ▣ → <i>Select density</i> → ▣</li> </ul>

## Double Number

## All Modes

Omitting Handset Code entry when switching modes	<ul style="list-style-type: none"> <li>▣ → <i>Settings</i> → ▣ → In Phone menu, <i>Double Number</i> → ▣ → <i>Password Entry</i> → ▣ → <i>Off</i> → ▣</li> <li>→ <i>Enter Handset Code</i> → ▣</li> </ul>
Renaming Double Number modes	<ul style="list-style-type: none"> <li>▣ → <i>Settings</i> → ▣ → In Phone menu, <i>Double Number</i> → ▣ → <i>Mode Name</i> → ▣ → <i>Select mode</i> → ▣ → <i>Enter name</i> → ▣ → <i>Select icon</i> → ▣</li> </ul>

## A Mode &amp; B Mode

Showing indicator for calls missed or new mail on idle line	<ul style="list-style-type: none"> <li>▣ → <i>Settings</i> → ▣ → In Phone menu, <i>Double Number</i> → ▣ → <i>Show Missed</i> → ▣ → <i>On</i> → ▣</li> </ul>
Hiding Internet connection confirmation	<ul style="list-style-type: none"> <li>▣ → <i>Settings</i> → ▣ → In Phone menu, <i>Double Number</i> → ▣ → <i>Packet Warning</i> → ▣ → <i>Off</i> → ▣</li> </ul> <ul style="list-style-type: none"> <li>• Available for B Mode.</li> </ul>

## Dual Mode

Rejecting calls to either line in Dual Mode	<ul style="list-style-type: none"> <li>▣ → <i>Settings</i> → ▣ → In Phone menu, <i>Double Number</i> → ▣ → <i>Reject By Line</i> → ▣ → <i>Select line</i> → ▣ → <i>On</i> → ▣</li> </ul>
Setting main line for Dual Mode	<ul style="list-style-type: none"> <li>▣ → <i>Settings</i> → ▣ → In Phone menu, <i>Double Number</i> → ▣ → <i>Send Priority</i> → ▣ → <i>Select option</i> → ▣</li> </ul>

## Battery Meter

### ? --- appears

- Calculating time; not a malfunction.

### ? 100% does not appear

- This is by design; not a malfunction.

### ? Battery runs out faster

- A low ambient temperature reduces battery time.
- An older battery may run out faster.

### ? Remaining time changes suddenly

- Time estimated by handset status; estimate may take time to appear.

## TOUCH CRUISER

### ? TOUCH CRUISER does not activate (or activates too quickly)

- Adjust activation response; see P.1-29 "Changing activation timing/method."

### ? TOUCH CRUISER deactivates too quickly or too slowly

- Adjust active time; see P.1-29 "Changing inactivity time limit."

### ? Cursor moves too fast or too slowly

- Adjust cursor response; see P.1-29 "Changing cursor speed."